

KOMATSU

D375A-8

CRAWLER DOZER

PRELIMINARY

D375



ENGINE POWER

Forward:
474 kW / 636 HP @ 1.800 rpm
Reverse:
578 kW / 775 HP @ 1.800 rpm

OPERATING WEIGHT

72.900 kg

BLADE CAPACITY

Semi-U blade: 18,5 m³
U blade: 22,0 m³

Walk-Around

D375A-8



Images may display optional equipment or specifications not available in your area.

ENGINE POWER

Forward:
474 kW / 636 HP @ 1.800 rpm
Reverse:
578 kW / 775 HP @ 1.800 rpm

OPERATING WEIGHT

72.900 kg

BLADE CAPACITY

Semi-U blade: 18,5 m³
U blade: 22,0 m³



OUTSTANDING PRODUCTIVITY & ENHANCED FRAME DURABILITY ENHANCED RIDE PERFORMANCE & WIDE AND EXCELLENT VISIBILITY

Ecology & Economy Features

- Komatsu EU emission regulations exempt engine **NEW**
- Auto idle stop function **NEW**

Performance Features

- 20% more power in reverse increases productivity **NEW**
- Automatic transmission with lockup torque converter
- Selectable working modes
- Automatic/manual gearshift selectable modes

First-Class Operator Comfort

- Comfortable ride with equalizer bar shoulder pad **NEW**
- Comfortable ride with new cab damper mounts **NEW**
- Comfortable ride with new operator seat **NEW**
- Excellent visibility for blade/ripper work **NEW**
- Renewed steering and work equipment lever with optimized layout **NEW**
- Rear view monitor system
- Electronic height adjuster for steering console **NEW**

Safety Features

- Rear platform & guard rails **UPGRADE**
- Heavy duty steps and large hand rails **UPGRADE**
- Secondary engine shutdown switch **NEW**
- Seat belt caution indicator **NEW**
- Power ladder (Optional) **NEW**
- Battery and starter isolator (Optional)
- Emergency engine stop switches (Optional)

Reliability & Maintenance Features

- Robust main frame and track frame **NEW**
- Modular long life powertrain design
- Mesabi* radiator **NEW**
- Hinged type front mask and cooling fan support **NEW**
- One side greasing points for work equipment

* Mesabi radiator is a trademark of L&M Radiator, Inc.

Information & Communication Technology

- Machine monitor with high resolution 7-inch color Liquid Crystal Display (LCD) unit **NEW**
- Energy Saving Operation **NEW**



KOMTRAX PLUS

- Increased operational data and fuel savings



A maintenance program
for Komatsu customers

Ecology & Economy Features

NEW ENGINE TECHNOLOGIES

Komatsu EU emission regulations exempt engine

Komatsu provides a powerful and economical engine with latest emission control technologies and fuel saving features.

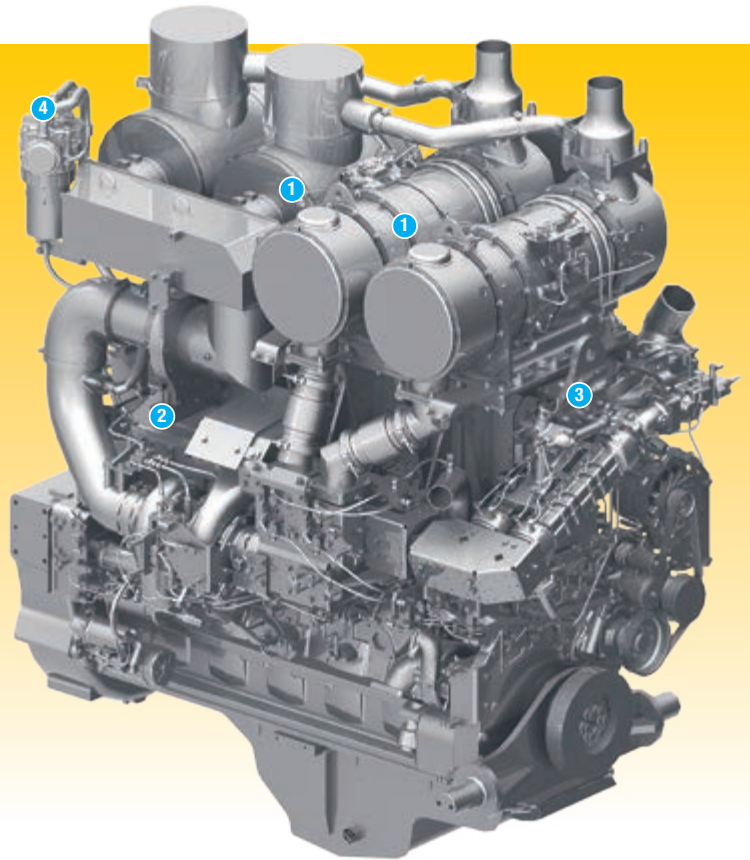

- ① Komatsu Diesel Particulate Filter (KDPF)
- ② Variable Geometry Turbocharger (VGT)
- ③ Exhaust Gas Recirculation (EGR) cooler
- ④ Komatsu Closed Crankcase Ventilation (KCCV)

Heavy-duty aftertreatment system

KDPF captures more than 90% of Particulate Matter (PM). Special oxidation catalyst and extra fuel injection in the exhaust stream can decompose accumulated soot in the KDPF filter by either active or passive regeneration. This system does not require any additional operator's action or interrupt normal operation.

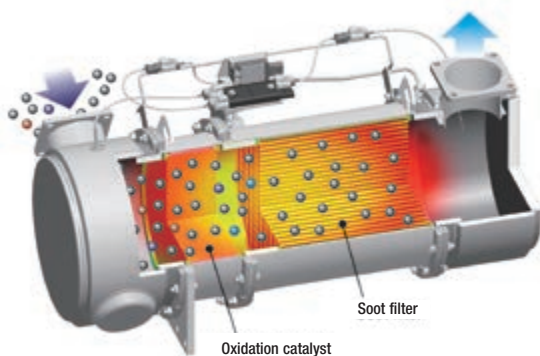

VGT system

The VGT system features Komatsu design hydraulic technology for variable control of air flow and supplies optimal air according to load conditions. The upgraded version realizes better exhaust temperature management.

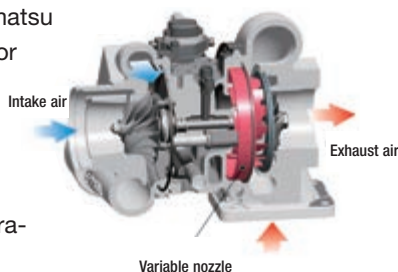

Heavy-duty cooled Exhaust Gas Recirculation (EGR) system

The system recirculates a portion of exhaust gas into the air intake and lowers combustion temperatures, thereby reducing NOx emissions. While EGR gas flow is increased, by incorporating a high-efficiency and compactly designed cooling system, the system achieves a dynamic reduction of NOx, while helping to reduce fuel consumption.

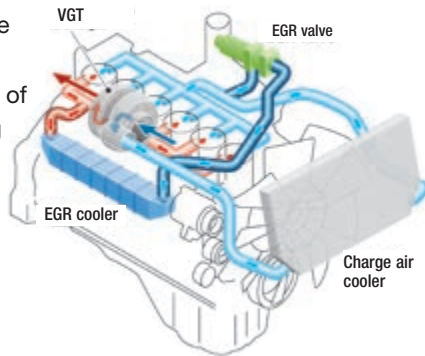

High Pressure Common Rail (HPCR) fuel injection system

The system is designed to achieve an optimal injection of high-pressure fuel by means of computerized control, thereby bringing close to complete combustion to reduce Particulate Matter (PM) emissions.

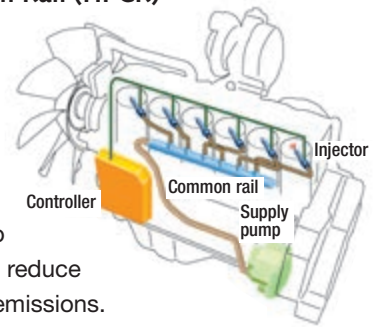

Hydraulic drive radiator cooling fan

The engine cooling fan rotation speed is electronically controlled. The fan rotation speed depends on engine coolant, powertrain oil and hydraulic oil temperatures, the higher the temperature the higher the fan speed. This system increases fuel efficiency, reduces the operating noise levels and requires less horsepower than belt driven fan.

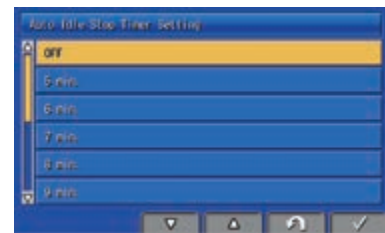

Komatsu auto idle stop

Komatsu auto idle stop helps reduce idle time and operating costs.

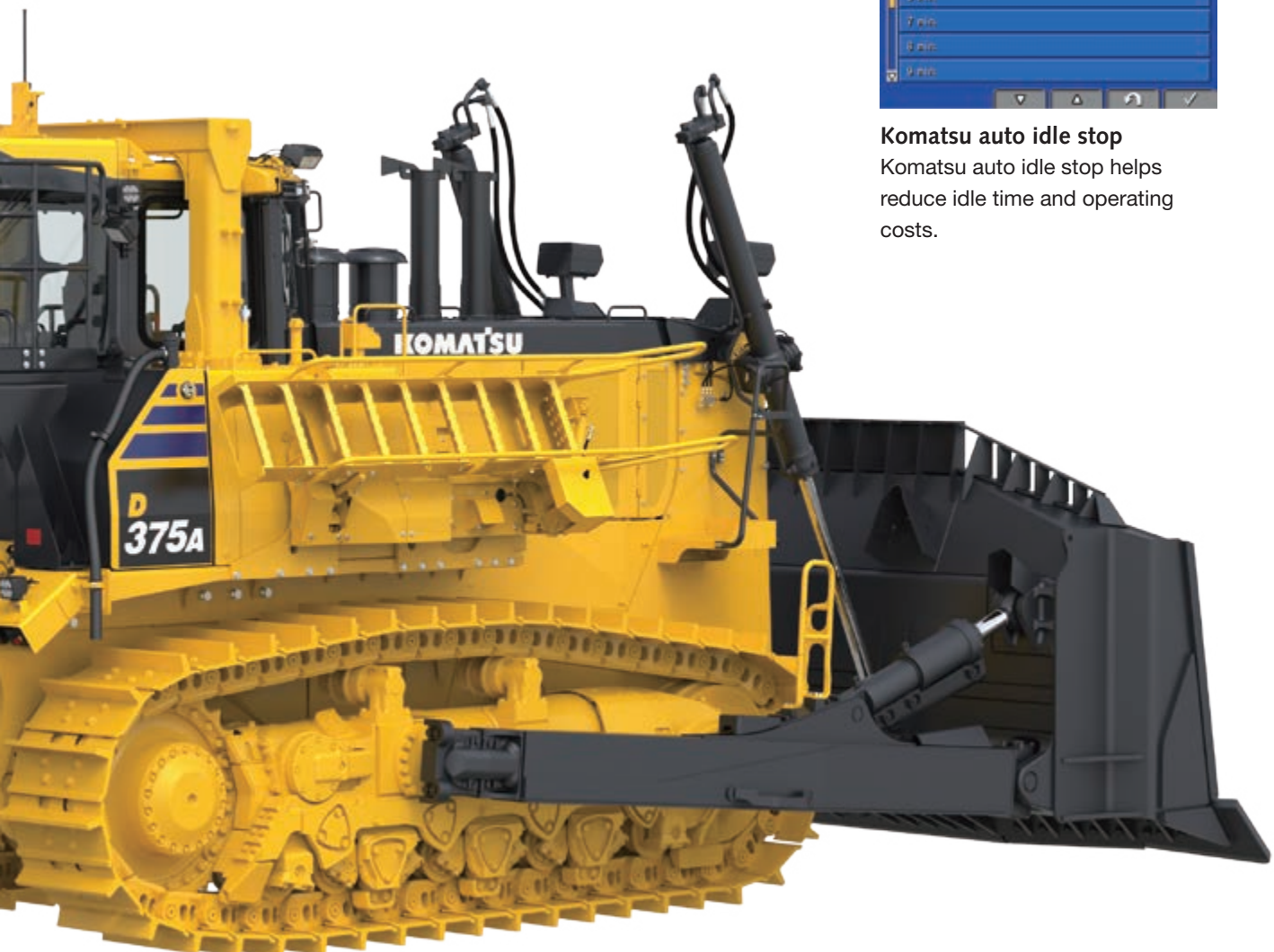

Performance Features

20% more power in reverse

Increased engine output by 1.2 times when in reverse provides faster reverse climbing speed in downhill dozing. It leads to reduction of cycle time and increases the production drastically.

In downhill dozing (13°)

Production increased by **18%**

Compared with D375A-6

Automatic transmission with lockup torque converter

A sharp reduction in fuel consumption and greater power train efficiency is achieved by the automatic gearshift transmission and lock up torque converter. The automatic gearshift transmission selects the optimal gear range depending on the working conditions and load placed on the machine. This means the machine is always operating at maximum efficiency. (Manual gearshift mode is selectable with a switch)

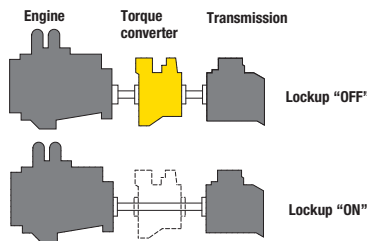

Fuel consumption reduced by **10%**

Compared with manual gearshift mode

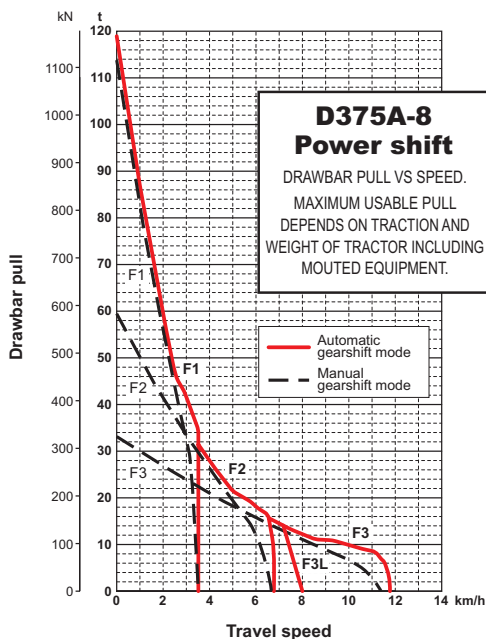

Lockup mechanism of torque converter is automatically actuated to transfer engine power directly to the transmission in usual dozing speed range. Locking up the torque converter eliminates loss of horsepower by 10%. Because the electronically controlled engine is extremely efficient, a decrease in fuel consumption is realized while also maintaining machine power.

Selectable working modes

This mode can be set to either "P mode" for the maximum power or "E mode" for energy saving operation. Combined with the automatic gearshift mode or manual gearshift mode, the working mode allows the operator to select the optimum machine operating condition for the work at hand. (The mode can be switched during operation.)

P mode (Power mode): With P mode, the engine outputs its full power. Select this mode for the work requiring large production, heavy-load work, and uphill work.

E mode (Economy mode): Select for energy saving operation with restricted engine power output. Select for the work on a ground where the machine may cause shoe slip and frequent decelerator pedal operation is required. Select for the work not requiring large power such as downhill dozing, levering, and light-load work.

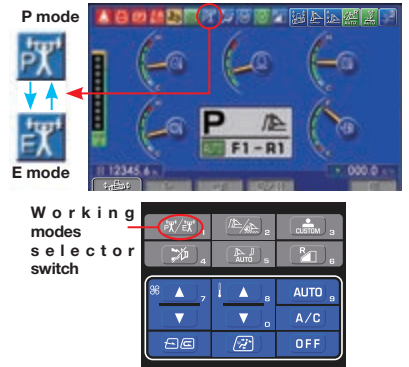

Automatic/manual gearshift selectable modes

Automatic or manual gearshift modes can be selected with ease to suit the work at hand by simply pressing the switch on the multi-monitor (Selection at neutral).

Automatic gearshift mode: The mode for general dozing. When a load is applied, the gear automatically shifts down, and when the load is off, it automatically shifts up to a set maximum gear speed. This mode economizes both fuel and production where the torque converter lockup mechanism is actuated according to load, automatically selecting the optimum gear speed.

Manual gearshift mode: The mode for dozing and ripping rough ground. When loaded, the gear automatically shifts down, but does not shift up when the load is off. The operator can specify whether the auto shift down function is enabled or disabled by operating the monitor.

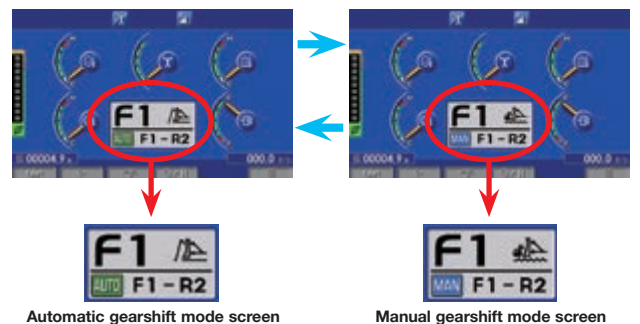

Preset travel speed selection function

Preset travel speed enables the operator to select fore and aft travel speed among four preset patterns. When the gearshift pattern is set to either <F1-R1>, <F1-R2>, <F2-R2>, or <F2-R3L>, in automatic gearshift mode, the gear is automatically shifted. This function reduces gear shifting time during repeated round-trip operations.



High efficiency blade and end bit design

Similar to the D375A-6, this new generation also uses the high efficiency Blade and End Bit design, to maximize your productivity.



Automatic gearshift mode	Manual gearshift mode	Shoe slip control mode (Optional)
F1-R1 MODE Press DOWN switch ↑ ↓ Press UP switch	F1-R1 MODE Press DOWN switch ↑ ↓ Press UP switch	F1-R1 MODE Press DOWN switch ↑ ↓ Press UP switch
F1-R2 MODE Press DOWN switch ↑ ↓ Press UP switch	F1-R2 MODE Press DOWN switch ↑ ↓ Press UP switch	F1-R2 MODE
F2-R2 MODE Press DOWN switch ↑ ↓ Press UP switch	F2-R2 MODE	
F2-R3L MODE		

Auto downshift function

When load is applied, the transmission automatically downshifts to the optimum gear speed to provide high fuel efficiency. This function provides comfortable operation in dozing without manual downshifting.

Reverse slow mode

With the reverse slow mode, the engine speed is limited to reduce reverse travel speed in order to improve ride quality such as rough terrain operation.

Electronic smooth steering clutch/brake control

Sensors monitor machine operating conditions such as incline angle of slope and degree of load, controller selects the optimal modulation parameter automatically. The timing of engagement for clutch and brake is optimized to provide more smooth steering control.

Track shoe slip control mode

Standard track shoe slip control mode allows the operator not to constantly control engine power output with the decelerator pedal while ripping operation, substantially reducing operator fatigue. Maneuverability is improved because the operator is free to focus on monitoring to track shoe slippage. Repair costs are significantly lowered and undercarriage life is extended with the reduction in track shoe slippage. Additionally, this mode will contribute to lower fuel costs because the engine output is automatically controlled to optimum level for operation.

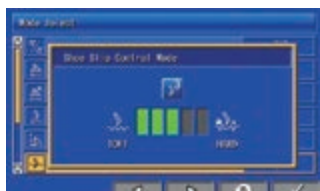

High penetration force by variable giant ripper

The variable giant ripper is a parallelogram single shank ripper ideal for ripping tough material. The ripping angle is variable, and the deeper reach of shank allows the operator to dig up a larger rock easily. Ripper shank height is adjustable in three stages by a hydraulically controlled pin puller.



First-Class Operator Comfort

Comfortable ride with equalizer bar shoulder pad

Shoulder pad on the equalizer bar makes machine behavior smoother when driving over the obstacles. Additionally, reduced oscillation angle of equalizer bar suppresses machine rolling behavior. Those improvements provide more comfortable environment for operator in rough terrain operation.

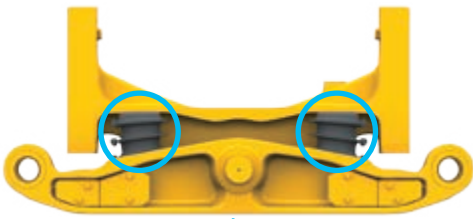

Comfortable operator seat

New air suspension operator seat drastically improves vibration absorption performance. Furthermore, uniformed body pressure management increases contact area with body, which enhances hold performance and fatigue reduction for operator. This seat equips the lumbar support, tilting adjust function, electric heater and ventilator. It is easy to adjust to the various physical size of operator and also the electric heater makes it possible to work comfortably in the winter. And ventilator makes it possible too, in the summer.



Heater & ventilator

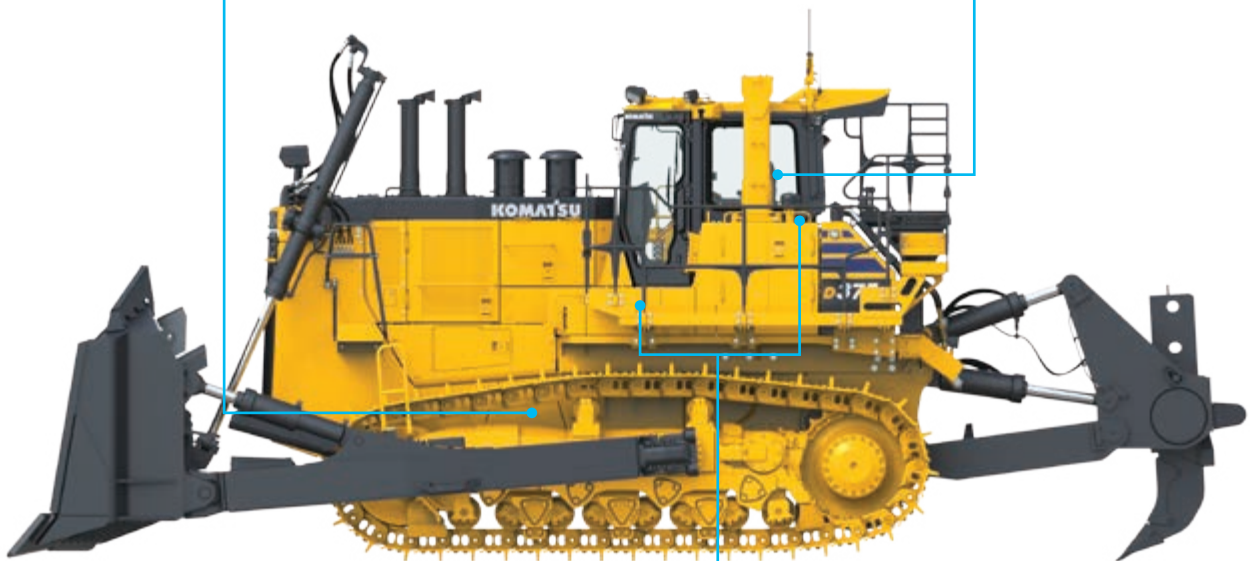

Comfortable ride with new cab damper mounts

The D375A-8's cab mount uses a new cab damper which provides excellent shock and vibration absorption capacity with its long stroke. These mounts soften shocks and vibration while traveling. Also, isolated cab from the machine body provides comfortable operation environment with less vibration and noise.

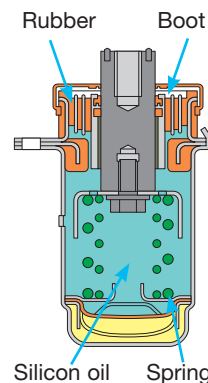

D375A-8



New design monocoque cab

The D375A-8 has a tall and spacious cab with large glass windows for outstanding visibility. High rigidity structure greatly reduce noise and vibration for the operator and helps prevent dust entering into the cab. Optimum arrangement of fixed operator seat contributes to enhance the blade visibility drastically, and enables to design the optimized lever and pedal layout, which provides comfortable work environment for operator.

Enlarged visible area of ripper shank

Thanks to the new ripper arm structure, the visible area of ripper shank is drastically enlarged. Operator is easy to rip the hard rock by locating the front edge of shank accurately.

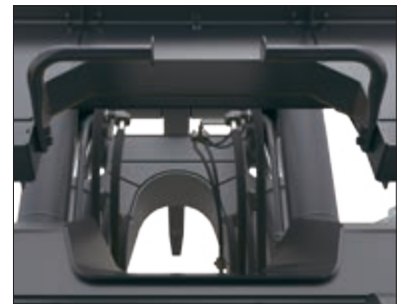

Optimized lever and pedal layout



Enlarged foot space

New fixed operator seat layout

Rear view monitor system

The operator can view the rear of the machine with a color monitor screen.



First-Class Comfort

Palm command control system (PCCS)

Ergonomically designed palm command travel joystick provides the operator with a relaxed posture and superb control improving operator comfort. Transmission gear shifting is simplified with push buttons.

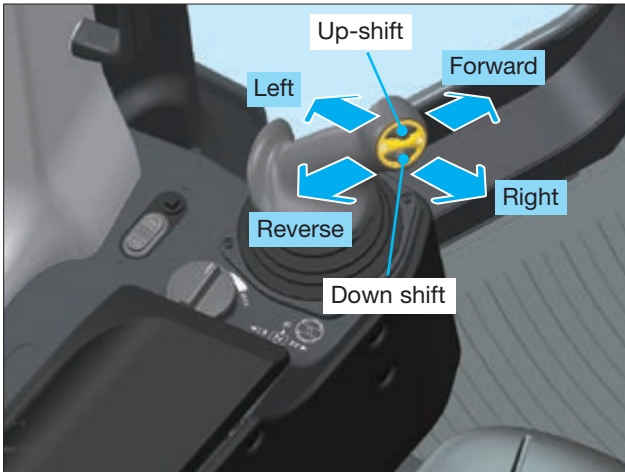

Electronic controlled work equipment control joystick

Electronically controlled work equipment control joystick allows operator to control blade and ripper quicker and more accurate than ever before. Blade fine control mode enables more smooth control for finish grading operation.

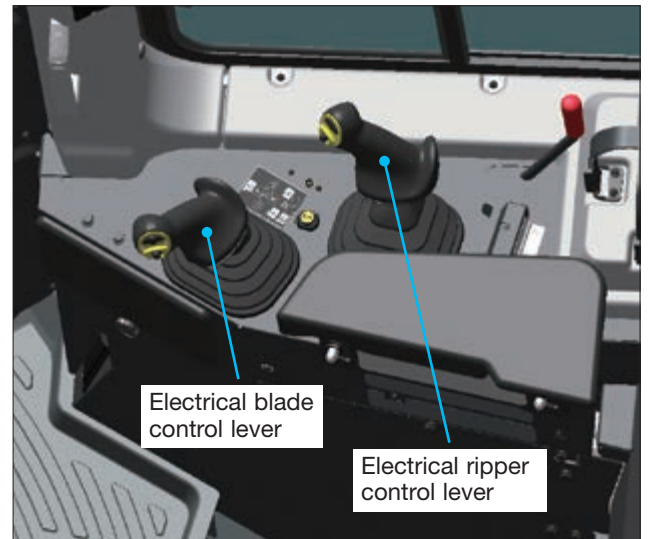

Finger command control system (FCCS) (optional)

Newly developed Finger Command Control System allows operator to support his own body by hand firmly when traveling on uphill slope in reverse or on rough ground. Forward/Reverse can be selected by rocker switch and Right/Left steering control by finger-tip handle.

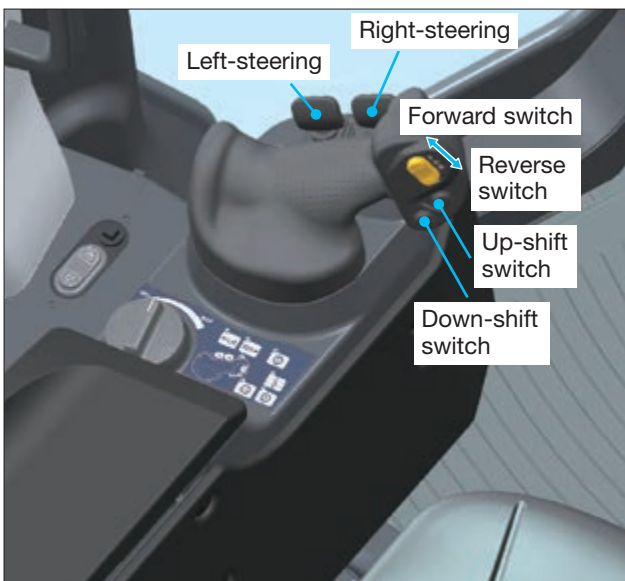

Palm command ripper control joystick

Newly attached the one way ripper control joystick allows operator to hold his own body by hand while ripping.

Tilt in ⇔ Tilt back with toggle switch
Ripper down ⇔ Ripper raise with one way lever

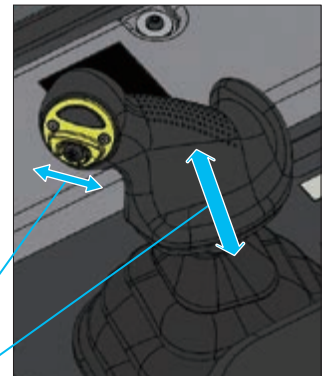

Blade auto-pitch*

To reduce operator effort and increase operating efficiency, the new auto blade pitch mode sets blade pitch position between digging and dump positions while dozing. By pressing the auto-pitch switch it will toggle the pitch position from digging to dump position with no additional lever movements. The blade pitch control can be set through the monitor to automatically return to the digging position when in reverse.

* Requires dual tilt dozer

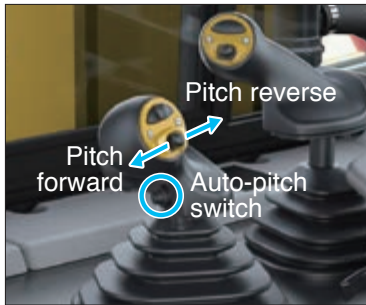

Ripper auto-return

The ripper control lever incorporates an auto-return function that will automatically raise the ripper, so the operator is less fatigued at the end of the day. The function activates automatically when travel lever is moved to reverse position.

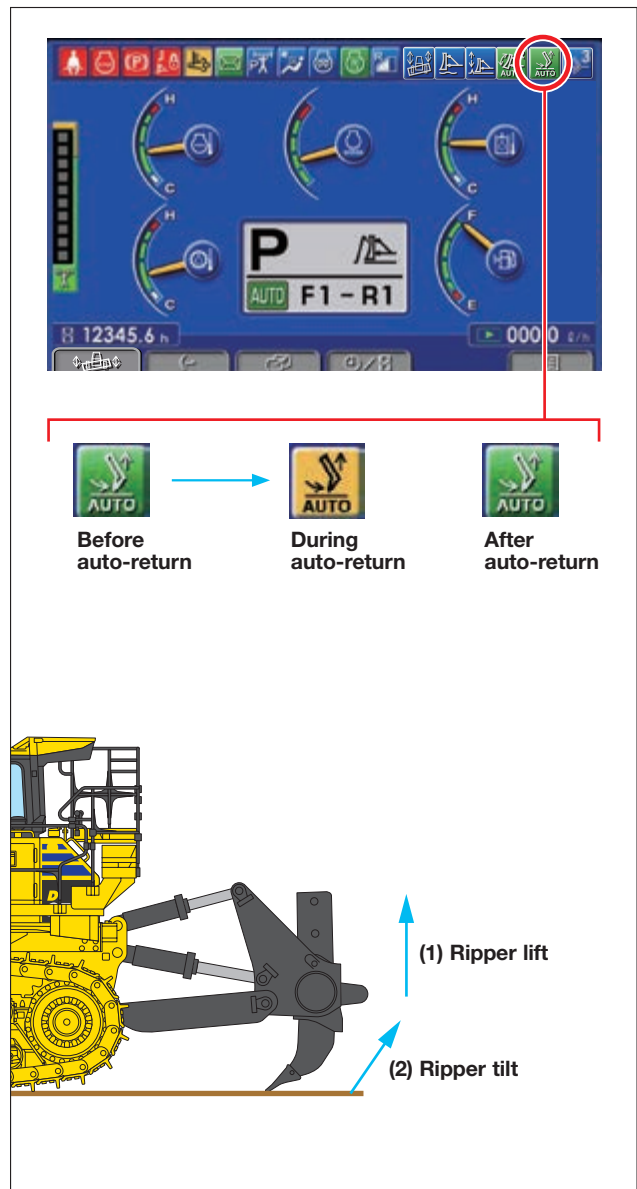
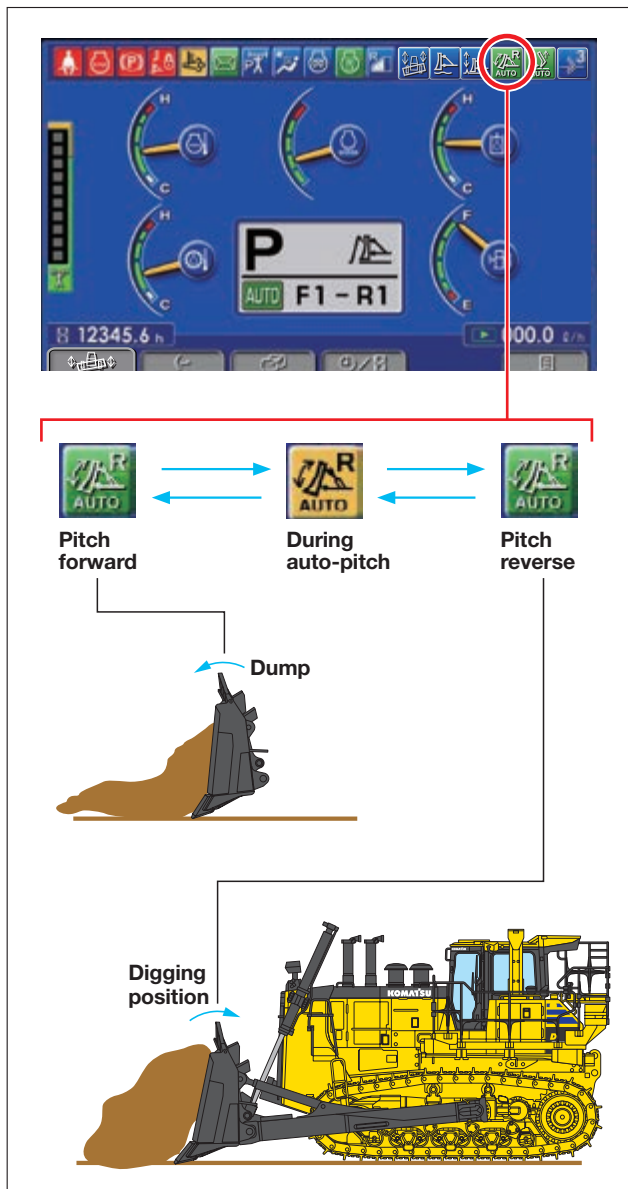
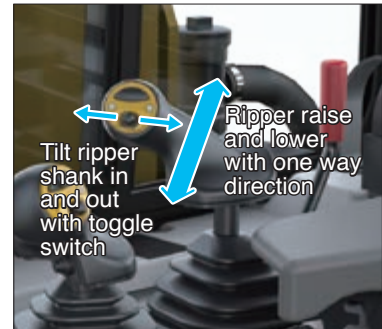

First-Class Comfort



Large size armrest

Wide armrest allows operator to put his elbow easily and support his own body during ripping work.



Electronic height adjuster for steering console

Height adjuster of steering console by electronic motor-driven provides easy height adjustment before starting operation.



Automatic climate control system

Automatic climate control system allows the operator to set the cab ambient temperature easily by the switch panel. Enhanced heating/cooling capacity and optimized wind outlet location keep the cab environment comfortable throughout the year.



12V outlet power source and aux input jack

Two 12V outlet power source and AUX input jack is equipped around left side of console.

- 24V cigarette lighter
- AUX input jack
- 12V outlet
- 12V outlet



D375A-8

Safety Features

One side platform with hand rails and toe boards

One side platform gives operator to access safely to rear maintenance points. Check and refilling of fuel and washer, cleaning of cab window glass and air conditioner condenser, cab lights, etc., can be safely performed.



Heavy duty steps and large hand rails

Strategically placed grab handles with non-slip steps aid operator getting on and off the machine.



Secondary engine shutdown switch

Secondary engine shutdown switch is newly equipped at the side of machine monitor. This is helpful when engine cannot shutdown normally via starting key switch.



Seat belt caution indicator

Reminds the operator to engage the seat belt.

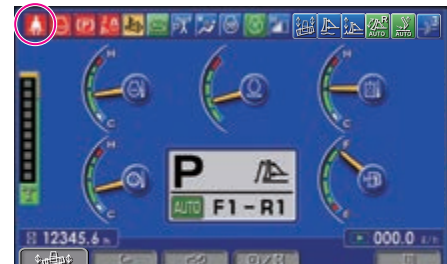

Power ladder (optional)

Provides safer access and egress to and from the cabin.



Battery and starter isolator box (optional)

- Starter isolator
- Jump start receptacle
- Battery isolator

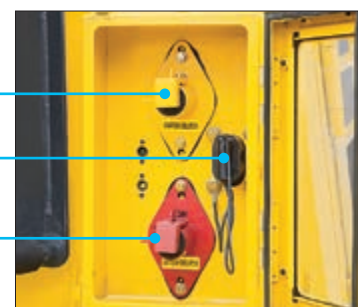

Emergency engine stop switches (optional)

In case you need to stop the engine immediately by using either of the two switches. One is installed in the cab, the other at the right rear of the machine.



Reliability & Maintenance Features

Main frame strength

D375A-8's main frame enhances its durability drastically with 125% stiffness increase compared with previous machine.

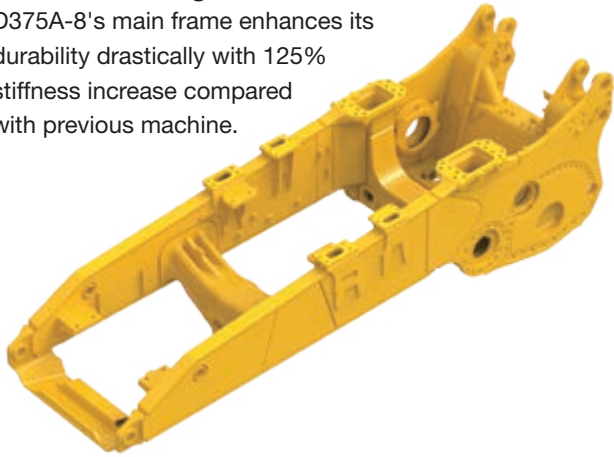

Mesabi radiator* installed

Mesabi radiator is equipped as standard cooling system. Easy exchangeable tube and less clogging performance contribute to easy maintenance and less downtime. * Mesabi radiator is a trademark of L&M Radiator, Inc.



Swing fan

Easy access to the front-side of radiator core for cleaning by swing fan and foldable mask structure.



- Swing fan
- Easy to clean core
- Foldable mask

New mono blade linkage

This structure provides less blade sway movement and extends maintenance interval of blade joint.

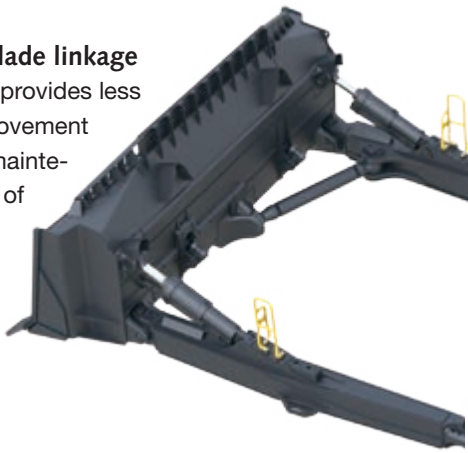

ONE SIDE GREASING POINTS

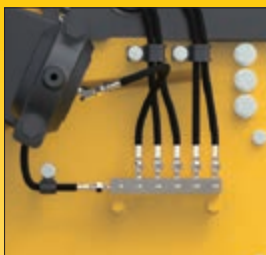

Blade lift cylinder yoke

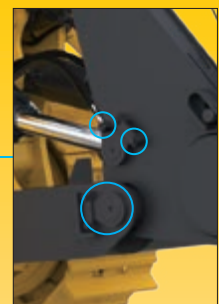

Ripper joints (Optional)

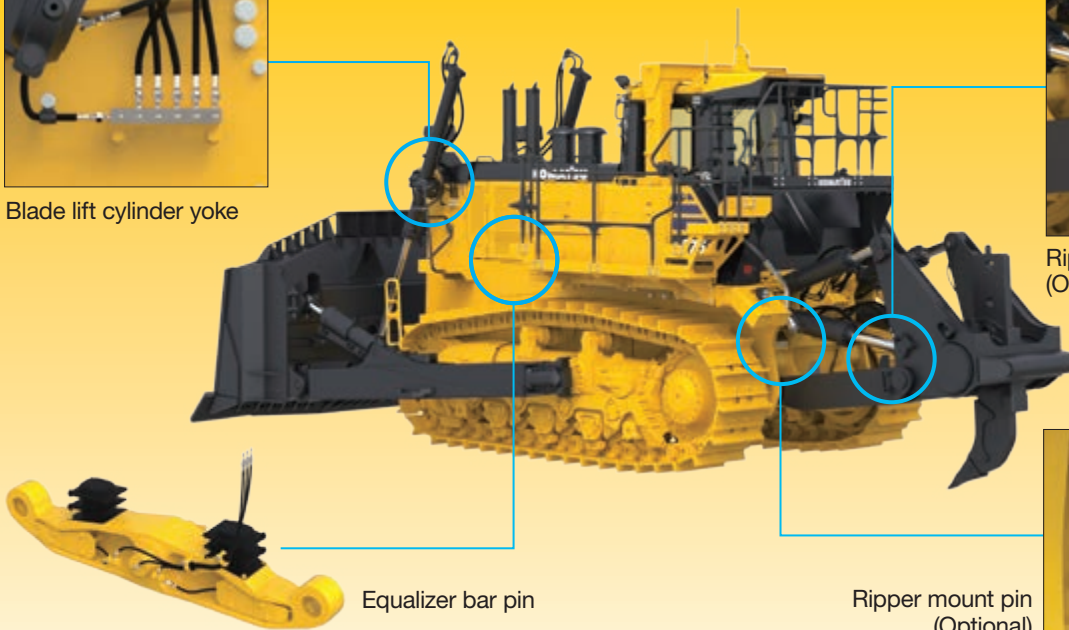

Equalizer bar pin



Ripper mount pin (Optional)

D375A-8

Maintenance service center (optional)

Couplings (Made by Wiggins) installed at the rear left of the machine enable quick drain and change of oil and coolant. The Fast Fuel Fill (Also by Wiggins) enables refueling from ground level. The service center eliminates the need to get on/off the machine and to remove/install covers to perform fluid maintenance.



Hydraulic oil
Transmission oil
Engine oil
Radiator coolant
Fast Fuel Fill

Canister-type breathers (optional)

Canister-type breathers are arranged inside the left exterior cover to facilitate check and cleaning of the breather of each component remotely.

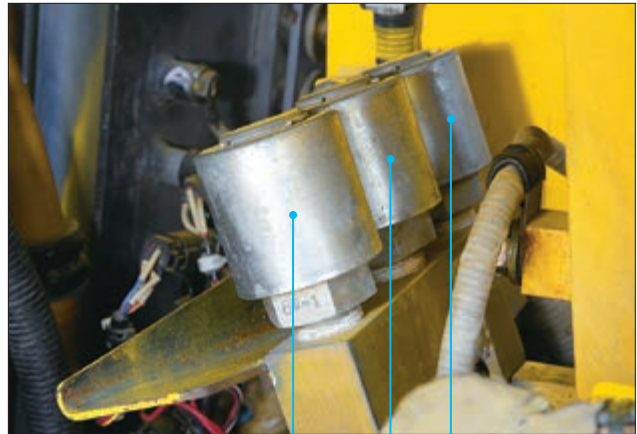

Damper case
Flywheel housing
Powertrain case

Concentrated sampling points (optional)

Concentrated sampling points are arranged inside the right side cab step cover to facilitate sampling of the oil and coolant from each component remotely.

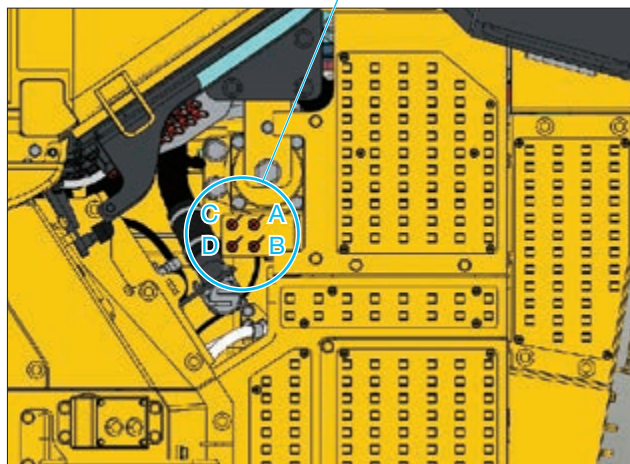

A: Radiator coolant
B: Hydraulic oil
C: Engine oil
D: Transmission oil

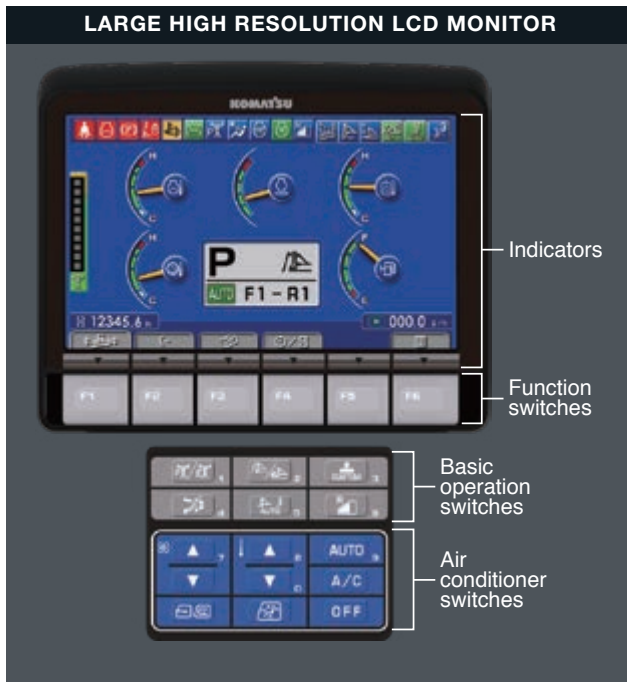

Large multi-lingual high resolution LCD monitor

A large user-friendly color monitor provides easy to understand information for the operator. Excellent screen visibility is achieved by use of a high resolution LCD monitor that can easily be read at various angles and lighting conditions. Simple and easy to operate switches. Plus function keys facilitate multi-function operations. The monitor displays data in 26 languages to globally support operators around the world.

Multi-monitor with troubleshooting function to minimize down time

Various meters, gauges and warning functions are centrally arranged on the multi-monitor. The monitor simplifies start-up inspection and promptly warns the operator with a lamp and buzzer if any abnormalities should occur. In addition, warning levels are indicated in 4 levels advise the operator of recommended actions. Replacement times for oil and filters are also indicated.



Energy saving operation ECO guidance

In order to support to optimum operation, the following 5 guidance is displayed for fuel saving operation

- 1) Avoid excessive engine idling
- 2) Use economy mode to save fuel
- 3) Avoid hydraulic relief pressure
- 4) Avoid over load
- 5) Use automatic shift mode

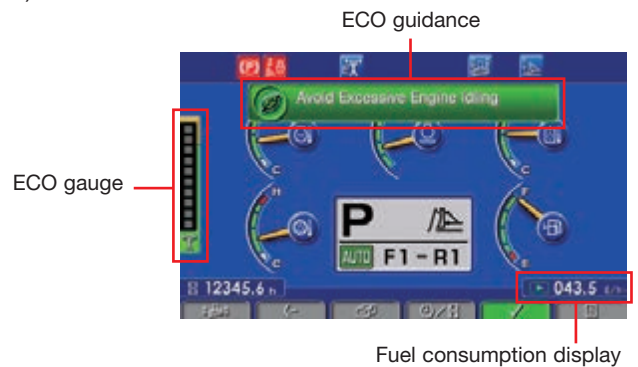

ECO gauge

In order to help the operator to perform in an environmentally friendly way and minimize energy consumption, an easy-to-read "ECO gauge" is displayed on the left of the multi-monitor screen.

Fuel consumption display

Average fuel consumption during the day is displayed on the right of the multi-monitor screen and updated every 10 seconds.

Operation record, fuel consumption history, and ECO guidance record

The ECO guidance menu enables the operator to check the operation record, fuel consumption history and ECO guidance record by pushing the button on the monitor. The records can be used to reduce the overall fuel consumption.



Operation record



Fuel consumption record

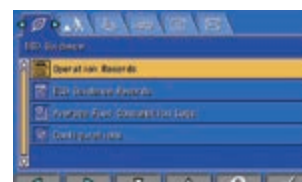

ECO guidance record

Komtrax Plus

What

- KOMTRAX™ is Komatsu's remote equipment monitoring and management system
- KOMTRAX™ continuously monitors and records machine health and operational data
- Information such as fuel consumption, utilization, and a detailed history aids in making repair or replacement decisions

Who

- KOMTRAX™ is standard equipment on all Komatsu construction products

When

- Know when your machines are running or idling and make decisions that will improve your fleet utilization
- Detailed movement records ensure you know when and where your equipment is moved
- Up to date records allow you to know when maintenance was done and help you plan for future maintenance needs

Where

- KOMTRAX™ data can be accessed virtually anywhere through your computer, the web or your smart phone
- Automatic alerts keep fleet managers up to date on the latest machine notifications

Why

- Knowledge is power - make informed decisions to manage your fleet better
- Knowing your idle time and fuel consumption will help maximize your machine efficiency
- Take control of your equipment - any time, anywhere



KOMTRAX Plus

Equipment management support

KOMTRAX™ Plus enables expanded monitoring of the fleet via satellite and wireless LAN. Users can analyze "machine health" and performance from a remote location, on a near-real time basis. This includes component condition and trend data. By making this critical information readily accessible, KOMTRAX™ Plus is an effective tool in maximizing productivity and lowering operating cost.

Specifications

ENGINE

Model	Komatsu SAA6D170E-7
Type	4-cycle, water-cooled, direct injection, turbocharged, air-to-air charge air cooler, cooled EGR
Engine power	
at rated engine speed	1.800 rpm
SAE J1995	Forward: 474 kW/636 HP Reverse: 578 kW/775 HP
ISO 9249 / SAE J1349* (net engine power)	Forward: 455 kW/609 HP Reverse: 558 kW/748 HP
No. of cylinders	6
Bore × stroke	170 × 170 mm
Displacement	23,15 l
Governor	Mid-range, electronic
Fan drive type	Hydraulic
Lubrication system	
Method	Gear pump, force lubrication
Filter	Full flow
Engine emissions	Exempt from EU exhaust emission regulations
*Net horsepower at the maximum speed of radiator cooling fan	Forward: 432 kW/580 HP Reverse: 536 kW/719 HP

MAX. TRAVEL SPEEDS

	Forward	Reverse
1st	3,5 km/h	4,6 km/h
2nd	6,8 km/h	8,9 km/h
3rd L	8,0 km/h	9,7 km/h
3rd	11,8 km/h	15,8 km/h

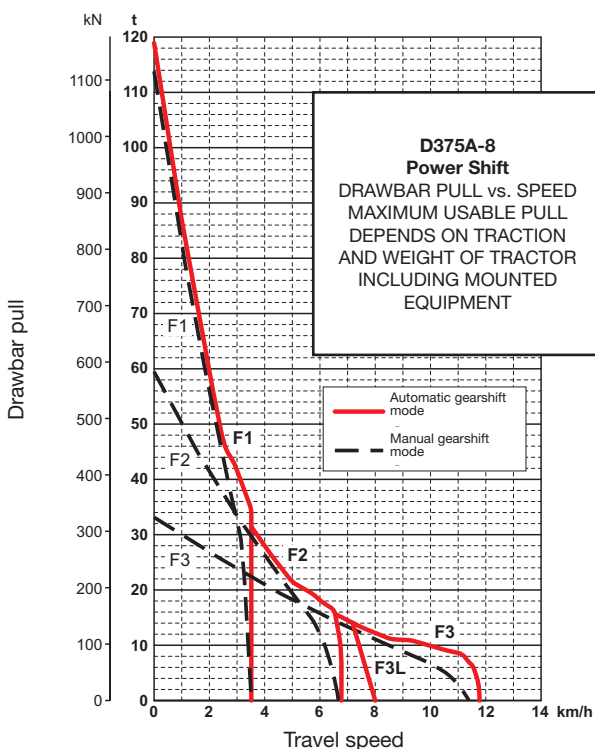

STEERING SYSTEM

Steering control	PCCS-lever
Service brakes	Wet, multiple-disc, pedal-controlled, spring-actuated and hydraulically released
Minimum turning radius (counter-rotation) (as measured by track marks on ground)	4,2 m

TORQFLOW TRANSMISSION

Type	Komatsu TORQFLOW
Torque converter	3-element, 1-stage, 1-phase, water-cooled, automatic lock-up
Transmission	Planetary gear, multiple-disc clutch hydraulically actuated, force-lubricated
Gearshift lock lever and neutral safety switch prevent accidental starts.	

UNDERCARRIAGE

Suspension	Oscillating equaliser bar with shoulder pad and pivot shaft
Track roller frame	Cylindrical, high-tensile-strength steel construction
K-Bogie undercarriage	Lubricated track rollers are resiliently mounted on the track frame with a bogie suspension system
Tracks	Lubricated tracks, fully sealed
Number of shoes (each side)	41
Grouser height (single grouser)	93 mm
Shoe width (standard)	610 mm
Ground contact area	48.560 cm ²
Track rollers (each side)	8
Carrier rollers (each side)	2

Extreme Service Shoes	Additional Weight	Ground Contact Area	Ground Pressure*
710 mm	680 kg	56.520 cm ²	4,6 km/h
810 mm	1.360 kg	64.480 cm ²	8,9 km/h

* Tractor

OPERATING WEIGHT (APPR.)

Including Semi-U tilt dozer, giant ripper, cab, ROPS (ISO 3471), operator, standard equipment, rated capacity of lubricant, coolant, and full fuel tank	
Operating weight	72.840 kg
Ground pressure	147 kPa / 1,5 kg/cm ²
Tractor weight	56.340 kg
Including rated capacity of lubricant, coolant, full fuel tank, operator, and standard equipment.	

SERVICE REFILL CAPACITIES

Fuel tank	1.200 l
Radiator	145 l
Engine oil	86 l
Torque converter, transmission, bevel gear and steering system	150 l
Dozer blade hydraulics	130 l
Giant ripper (additional capacity)	45 l
Multishank ripper (additional capacity)	45 l
Final drive (each side)	65 l

FINAL DRIVE

Type	Planetary gear, double-reduction
Sprocket	Segmented sprocket teeth are bolt-on for easy replacement

RIPPER EQUIPMENT

Multishank ripper	
Type	Hydraulically controlled parallelogram ripper
No. of shanks	3
Weight (including hydraulic control unit)	6.430 kg
Beam length	2.910 mm
Maximum lift above ground	1.155 mm
Maximum digging depth	1.485 mm
Giant ripper	
Type	Hydraulically controlled variable parallelogram ripper
No. of shanks	1
Weight (including hydraulic control unit)	5.210 kg
Beam length	1.600 mm
Maximum lift above ground	1.120 mm
Maximum digging depth	1.485 mm

HYDRAULIC SYSTEM

Type	CLSS (closed-centre load sensing system)
All spool valves externally mounted beside the hydraulic tank.	
Main pump	Variable displacement piston pump
Maximum steering pump flow	366 l/min
Relief valve setting	for implement 29,8 MPa 304 kg/cm ²
Spool control valve positions	
Blade lift	Raise, hold, lower, and float
Blade tilt	Right, hold, and left
Additional control valve positions for ripper	
Ripper lift	Raise, hold and lower
Ripper tilt	Increase, hold and decrease
Hydraulic cylinders	
No. of cylinders × bore	
Blade lift	2 × 140 mm
Blade tilt (single tilt)	1 × 200 mm
Blade tilt (dual tilt)	2 × 200 mm
Ripper lift	2 × 200 mm
Ripper tilt	2 × 180 mm

DOZER EQUIPMENT

	Overall length with blade	Blade capacity (ISO 9246)	Blade width × height with spill guard height	Max. lift above ground	Max. drop below ground	Max. tilt adjustment	Additional weight		
							Dozer Equipment	Hydraulic Oil	Ground Pressure*
Strengthened Semi-U Dozer	7.855 mm	18,5 m ³	4.775 mm × 2.525 mm	1.690 mm	734 mm	950 mm	11.280 kg	45 kg	148 kPa 1,51 kg/cm ²
Strengthened U Dozer	8.215 mm	22,0 m ³	5.215 mm × 2.525 mm	1.690 mm	734 mm	1.040 mm	12.330 kg	45 kg	150 kPa 1,53 kg/cm ²
Strengthened Dual Tilt Semi-U Dozer	7.855 mm	18,5 m ³	4.775 mm × 2.525 mm	1.690 mm	734 mm	1.170 mm	11.440 kg	50 kg	149 kPa 1,52 kg/cm ²
Strengthened Dual Tilt U Dozer with Spill Guard	8.215 mm	22,0 m ³	5.215 mm × 2.525 mm	1.690 mm	734 mm	1.280 mm	12.490 kg	50 kg	151 kPa 1,54 kg/cm ²

* Ground pressure shows tractor with cab, ROPS (ISO 3471), variable giant ripper, standard equipment and applicable blade.

DIMENSIONS

Semi-U dozer with giant ripper

D375A-8 Semi-U dozer	
A	2.500 mm
B	4.775 mm
C	4.160 mm
D	2.525 mm
E	1.690 mm
F	734 mm
G	3.980 mm
H	10.560 mm
I	3.460 mm
J	1.120 mm*1
K	1.485 mm*2
L	4.278 mm

Ground clearance: 610 mm

*1 Maximum lift above ground
*2 Maximum drop below ground

Standard and Optional Equipment

ENGINE AND RELATED PARTS

Komatsu SAA6D170E-7 turbocharged common rail direct injection diesel engine	●
Exempt from EU exhaust emission regulations	●
Starting motor 2 × 24 V/7,5 kW	●
Alternator 24 V/140 A	●
Batteries 2 × 12 V/200 Ah	●
Radiator reserve tank	●
Cooling fan	●
Hinged front mask	●
Hinged fan support	●
Fast fuel fill system	●
Starting motor 2 × 24 V/11 kW	○

UNDERCARRIAGE

Single grouser heavy-duty shoes (610 mm)	●
Eight-roller track frames	●
Segmented sprockets	●
Hinged underguards with front pull hook	●
Hydraulic track adjusters	●
Track shoe slip control system	●
Track roller guard	●
Single grouser heavy-duty shoes (710 mm, 810 mm)	○

SAFETY EQUIPMENT

Rear view camera system	●
Back-up alarm	●
Warning horn	●
Vandalism protection kit (Cover locks)	●

CABIN

Suspension seat: heated, ventilated, fabric, reclining, high backrest, turnable with headrest	●
2 point seat belt with visible alert	●
Perforated side covers	●
Air conditioner with heater and defroster	●
Radio	●
Platform with hand rails and toe boards	●
Two muffler with rain cap	●
Uninterrupted power source for 3rd party system	●
Wipers doors	●
Rear-view mirror (inside cab)	●
Lunch box holder	●
Power ladder	○

TRANSMISSION AND BRAKES

Final drive case wear guard	●
Torque converter with automatic lock-up	●
TORQFLOW transmissions	●
Wet steering clutches	●
Decelerator pedal	●
Palm lever steering control (PCCS)	●

SERVICE AND MAINTENANCE

Dry type air cleaner, double element with mechanical dust indicator and evacuator	●
Electrical dust indicator	●
Colour monitor	●
KOMTRAX™ Plus with Iridium	●

LIGHTING SYSTEM

LED lighting system	●
4 front and 2 rear LED lights	●
Head lights	●
1 ripper working light (halogen)	●
Inspection light (portable)	●

ATTACHMENTS

Hitch	●
Counterweight	○

HYDRAULIC SYSTEM

Hydraulics for dozing blades	●
Hydraulics for ripper	●

DOZER EQUIPMENT

Dual tilt dozer	●
Strengthened Semi-U blade	○
Strengthened U blade	○

MINING SPECIFICATIONS (PACKAGE)

Access lights	○
Canister-type breather	○
Concentrated sampling points	○
Evacuation service center	○
Remote grease lines for ripper	○
Isolator box	○
Manual emergency engine shutdown switches	○
Power ladder	○
Working light for the engine bay	○

Further equipment on request

- standard equipment
- optional equipment

Your Komatsu partner:

KOMATSU

**Komatsu Europe
International N.V.**

Mechelsesteenweg 586
B-1800 VILVOORDE (BELGIUM)
Tel. +32-2-255 24 11
Fax +32-2-252 19 81
www.komatsu.eu

EENSS20321P 09/2017

KOMATSU is a trademark of Komatsu Ltd. Japan.